



# PASCO 550 Universal Interface

Model No. UI-5001



## Table of Contents

<b>Equipment .....</b>	<b>1</b>
<b>Introduction .....</b>	<b>2</b>
<b>Computer Requirements for the 550 Universal Interface .....</b>	<b>2</b>
<b>General Operation Requirements and Setup .....</b>	<b>2</b>
A. Operation Requirements and Precautions.....	2
B. Connecting the 550 Universal Interface to Your Computer .....	3
C. Starting the 550 Universal Interface .....	4
D. Plugging a Sensor into the 550 Universal Interface .....	5
<b>Using the 550 Interface as a Signal Generator .....</b>	<b>5</b>
A. Connect the Interface.....	5
B. Setup the Signal Generator .....	5
<b>Troubleshooting .....</b>	<b>6</b>
<b>Appendix A: Specifications .....</b>	<b>7</b>
<b>Appendix B: Compliance .....</b>	<b>9</b>
<b>Appendix C: Frequently Asked Questions .....</b>	<b>9</b>
<b>Technical Support .....</b>	<b>11</b>
<b>Warranty, Copyright and Trademark Information.....</b>	<b>11</b>
<b>Product End of Life Disposal Information .....</b>	<b>11</b>

# UI-5001 550 Universal Interface

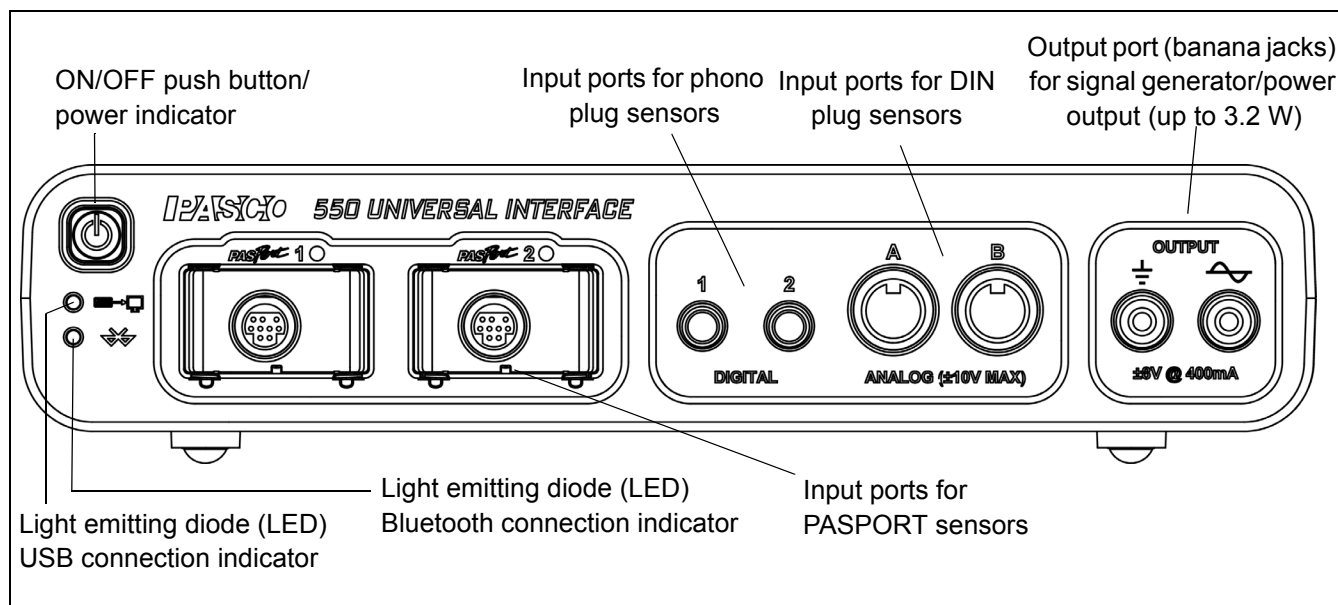

## Equipment

Included Equipment
1. 550 Universal Interface (UI-5001)
2. AC Adapter (with power cord)
3. USB cable



AC Adapter

USB Cable

Additional Equipment Required	Note
USB or Bluetooth compatible computer OR Bluetooth compatible tablet	
Any PASCO <sup>®</sup> sensor	A sensor with a PS-, CI-, ME-, SN-, or TD- prefix*
PASCO Data Collection Software	PASCO Capstone or SPARKvue <sup>1</sup>

\* Any PASPORT<sup>®</sup> or ScienceWorkshop<sup>®</sup> sensor can be used for real-time data collection.

<sup>1</sup>See the PASCO web site at [www.pasco.com](http://www.pasco.com) for more information about software.

Additional Equipment Recommended	Model Number
Shrouded Banana Plug Patch Cords (for Output)	EM-9740 (red) and EM-9745 (black)

# Introduction

## Interface

The PASCO® 550 Universal Interface is a multi-port data collection interface designed for use with any PASCO sensor and PASCO Data Collection software (available separately). Users can plug a sensor into one of the six input ports on the interface, perform the necessary setup in the Data Collection software and then begin collecting data. The software records, displays and analyzes the data measured by the sensor.

The 550 Universal Interface comes with a universal serial bus (USB) cable for connecting to a USB port, and a power supply (adapter with power cord) that converts input of 100 to 240 volts, alternating current (100 to 240V AC) to output of 15 volts, direct current, at two amps (15V DC at 2 A)

The 550 Universal Interface can also connect wirelessly to a Bluetooth-compatible computer or tablet.

The 550 Universal Interface has a built-in signal generator and power output. The power output ports provide up to 3.2 watts (W) of power. The interface can output direct current (DC) or alternating current (AC) in a variety of waveforms such as sine, square, and sawtooth. The interface has built-in voltage and current sensors that measure the output signal.

(Please note that the 550 Universal Interface is not compatible with the PASCO CI-6552A Power Amplifier because there is no ‘signal output’ from the DIN plug ports.)

**Note:** The 550 Universal Interface is compatible with all PASCO PASPORT sensors and *ScienceWorkshop* sensors. The PASPORT sensors have a “PS-” prefix, and the *ScienceWorkshop* sensors have a “CI-”, “ME-”, “SN-”, or “TD-” prefix. See the PASCO web site at [www.pasco.com](http://www.pasco.com) for more information about the sensors.

## Computer Requirements for the 550 Universal Interface

**Windows®-Based Computers:** Windows™ XP SP2 (or higher), 2 GHz (or higher) processor, 200 MB (megabytes) available disk space, 2 GB (gigabytes) RAM (random access memory), display size 1024 by 768. [The interface cannot be used with Windows 3.1, 95, ME, 2000, or NT 4.0].

**Macintosh Computers:** Mac OS X 10.6 (or higher), Intel CPU, 100 MB available disk space, 2 GB RAM.

## General Operation Requirements and Setup

### A. Operation Requirements and Precautions

- a) The 550 Universal Interface requires PASCO Capstone or SPARKvue software.
- b) The included power supply (AC adapter) is required for operation. Always plug the power cord of the AC adapter into a standard, grounded wall outlet.



**WARNING:** The interface is not water-proof. To avoid the risk of shock, keep the interface, AC adapter, and cable away from water and liquids. If conducting an experiment with liquids or water,

keep the liquid container away from the interface. For maximum protection, keep liquids in closed containers.

Also during operation, do not cover the slots on the top of the interface or the holes on the bottom of the interface. The slots and holes help prevent the interface from overheating during prolonged use.

## B. Connecting the 550 Universal Interface to Your Computer

The 550 Universal Interface can be connected to the computer with the included USB cable to a USB port on the computer or a USB hub connected to the computer or wirelessly through Bluetooth.

### USB Connection

1. Install PASCO Data Collection software on your computer.
2. Connect the larger end of the USB cable to a USB port on the computer or a USB hub connected to the computer.
3. Connect the smaller end of the USB cable to the USB port on the back of the interface.

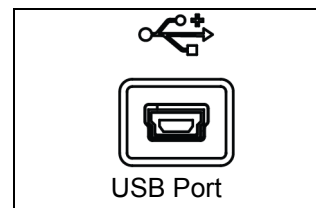

### Wireless (Bluetooth) Connection

- You will need to connect the 550 Universal Interface using your computer's operating system Bluetooth connection settings.
- For information about connecting the 550 Universal Interface wirelessly, refer to the Online Help System for the PASCO Data Collection software that you are using.
- For more information, check the "User Resources" tab on the PASCO web page for the 550 Universal Interface. Under the "User Resources" tab, look for videos related to setup.

## C. Starting the 550 Universal Interface

1. Connect the AC adapter to a grounded electric receptacle. Plug the end of the cord from the AC adapter into the 15V @ 2A power port on the back of the 550 Universal Interface.
2. On the left front corner of the interface, firmly press and hold the power push button. The interface will "beep" once and the green light emitting diodes (LEDs) above the PASPORT input ports will blink once. The push button has a blue LED that shines when the power is on.
3. The USB LED or the Bluetooth LED below the power push button should light up. If not, check the USB or Bluetooth connection between the interface and the computer.

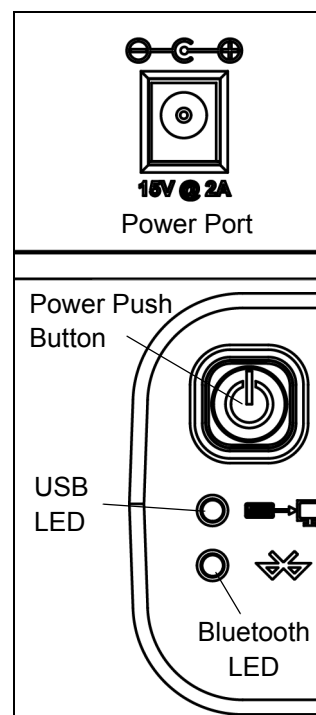

## D. Plugging a Sensor into the 550 Universal Interface

- PASPORT sensors plug into input ports labeled *PASPort*.
- *ScienceWorkshop* analog sensors with DIN connectors plug into the ANALOG ports labeled A and B on the interface.

- *ScienceWorkshop* digital sensors with stereo phono plugs connect into the DIGITAL ports labeled 1 and 2 on the interface.

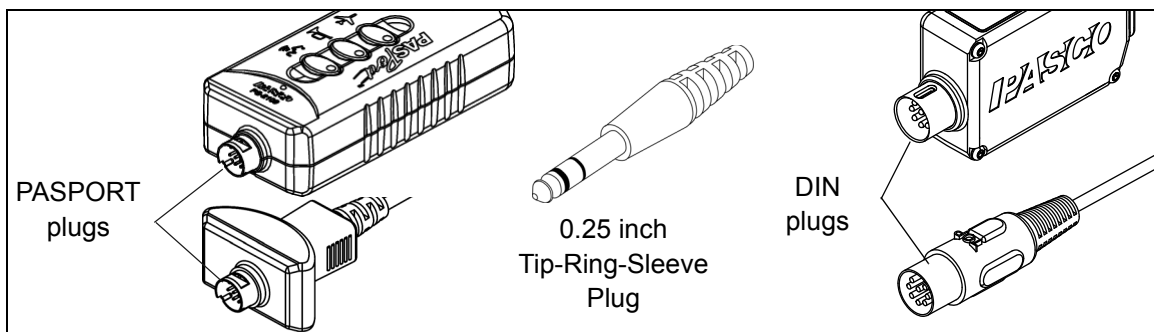

### Extender Cables

If you need extra distance between the sensor and the 550 Universal Interface, use an extender cable such as the UI-5218 8 pin 1.8 m DIN Extender Cable, the PS-2500 PASPORT Sensor Extension Cable, or the PI-8117 Phono Jack Extender Cable.

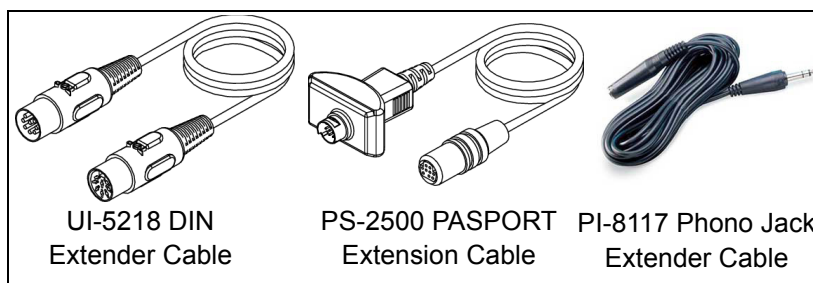

Please note that the 8-Pin DIN Cable Assembly that is included with several *ScienceWorkshop* sensors such as the CI-6504A Light Sensor can also be used as an extension cable.

DO NOT connect more than one extender cable between a sensor and the 550 Universal Interface. Connect the sensor directly to the interface or, at most, through one extender cable to the interface.

## Using the 550 Interface as a Signal Generator

### OUTPUT Ports – Front Panel

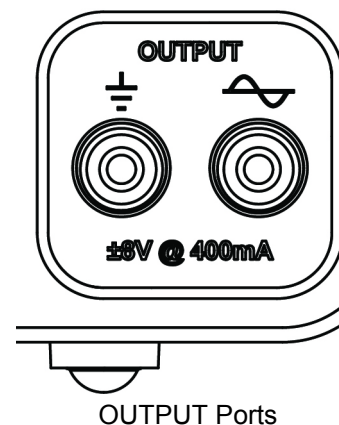

The PASCO 550 Universal Interface has a pair of signal output ports on its front panel. Each port is a four millimeter (4 mm) banana jack port. The ports can provide  $\pm 8$  volts at up to 400 milliamp (or 3.2 watts) for a variety of waveforms (sine, square, triangle, positive and negative ramps) or direct current (DC) if needed. The output frequency range for the waveforms is 0.001 hertz to 100,000 hertz (100 kHz) with a resolution of 0.001 Hz (1 mHz). The output has over-current detection, selectable voltage limiting, and selectable DC offset. In PASCO Capstone, the signal generator also has a frequency sweep function.

The output for the signal generator is controlled by PASCO Data Collection software (such as Capstone or SPARKvue). The interface can measure the output voltage and the output current.



## To use 550 OUTPUT as a Signal Generator for a Circuit (or Other Device):

### A. Connect the Interface

1. Insert a banana plug patch cord into the ground port () on the interface, and connect the other end of the cord to the ground on the circuit board (or other device).
2. Insert a banana plug patch cord into the signal generator port () and connect the other end of the cord to the positive lead on the circuit board (or other device).

### B. Setup the Signal Generator

- Use the PASCO Data Collection software to set up the Signal Generator.

*Refer to the Online Help and User's Guide for the software for information about setting controls for Signal Generator functions such as:*

Waveform	Voltage Offset
Sweep Type	Voltage Limit
Frequency	Current Limit
Amplitude	On, Off, Auto

- Controls for functions such as Frequency, Amplitude, Voltage Offset, and Voltage Limit may be adjusted in more than one way.

### Hints for Help

- *Use the Help menu to access the PASCO Capstone Help for detailed information about PASCO Capstone and the features of the Controls, Displays, Tools, palettes, and panels.*
- *Hover the cursor over an item to see its Tool Tip.*
- *Right-click on an item to see its contextual menu.*
- *In SPARKvue, touch the Help icon to open the SPARKvue User's Guide (Online Help System) for more information about the software*



# Troubleshooting

Problem	Recommendations
The interface does not turn on.	Ensure you have the power supply connected between the interface and a standard, grounded outlet. Check to see that the power push button is pushed in. Ensure that the USB cable is inserted properly to both the interface and to a USB port of your computer.
My computer's operating system does not recognize the interface and asks for a driver.	You must have Capstone version 1.3 or higher software loaded onto your computer. Capstone 1.0 includes a driver (set of software instructions) that allow your computer to communicate with the 550 Universal Interface. Check "Computer Requirements" in this manual to ensure your operating system is compatible with USB devices.
Capstone does not allow me to collect data with the interface connected.	Recheck the USB cable and power connections. Also, check to ensure you have the proper hardware setup selected in Capstone. In the <b>Hardware Setup</b> panel, click <b>Choose Interface</b> . See that <b>Autodetect</b> is checked, or click the <b>More</b> menu and see which interface is connected.
I want to collect data with both a 750 USB Interface and the 550 Universal interface simultaneously.	Capstone does not allow you to collect data from a <i>ScienceWorkshop</i> interface and other interfaces simultaneously. Instead, use the <b>Choose Interface</b> button in the Capstone <b>Hardware Setup</b> panel to alternate between interfaces.
I am unable to output a signal from the Signal Generator.	Check the <b>Signal Generator</b> panel to ensure you have selected <b>On</b> or <b>Auto</b> . Also check that the <b>Amplitude</b> is not "0". Also, check the <b>Sweep Type</b> and the <b>Duration</b> . If the <b>Sweep Type</b> is <b>Single</b> , the output signal will occur only one time. If the <b>Duration</b> is zero, there will be no signal.
The selected Display does not show any data after I click Record.	Check the <b>&lt;Select Measurement Here&gt;</b> menu for both the vertical and horizontal axes. Depending on what sensors are connected and the setup for the <b>Signal Generator</b> , each menu will have choices for you to select.



## Appendix A: Specifications

550 Universal Interface	Description
<b>Power (AC Adapter):</b>	100-240 V AC to 15 V DC at 2 A, 2.1 mm jack
<b>Computer Connection:</b>	Universal Serial Bus (USB) 2.0 high speed (480 Mbps); does not use any bus power, or Bluetooth (wireless)
<b>PASPORT Input Channels:</b>	Two PASPORT connections support all PASPORT sensors. Maximum sampling rate depends on the sensor being used.
<b>Digital Channels:</b>	Two input/output channels. Supports all 0 to 5 V transistor-to-transistor logic (TTL) type sensors. +5 V at 200 mA total for both channels. Digital input: Edge sensitive and sampled at 10 kHz (100 $\mu$ s), (1 $\mu$ S resolution for the Motion Sensor).
<b>High Speed Analog Channels:</b>	Two identical channels with differential inputs and 1 megaohm input impedance. Supports all 8-pin DIN analog sensors. $\pm 10$ V input voltage measurement range. Input protection: $\pm 250$ V continuous & common mode. Three voltage gain settings on each channel (1,10, and 100X). Bandwidth: Unity gain; 500 kHz.
<b>Analog Measurement (all sources):</b>	14-bit analog-to-digital converter (ADC), 1.22 mV resolution. Maximum sample rate: one channel at 1 million samples per second (Msps). Maximum rate depends on how many channels are selected. Trigger on any analog event (input or output), or digital event. Window buffer allows pre-trigger sampling. One voltage output, one current output.

---

**Signal Generator:**

Amplitude range:  $\pm 8$  V with 3.9 mV resolution, 12-bit digital-to-analog converter (DAC).

Maximum output current: 400 milliamp (mA) with over-current detection.

Selectable current limits:

Frequency range: 0.001 to 100,000 Hz with 0.001 Hz resolution.

Sweep functions: single, repeatable, bidirectional.

DC Voltage offset:

Waveforms: sine, triangle, square, positive ramp, negative ramp, DC.

Output disable function.

Output current measure: 61 microamp ( $\mu$ A) resolution.

---

## Appendix B: Compliance

### FCC Statement

This Class A digital device complies with part 15 of the FCC Rules. Operation is subject to the following two conditions: (1) This device may not cause harmful interference, and (2) this device must accept any interference received, including interference that may cause undesired operation.

### CE Statement

This device has been tested and found to comply with the essential requirements and other relevant provisions of the applicable EU Directives

## Appendix C: Frequently Asked Questions

### What is the 550 Universal Interface?

The PASCO 550 Universal Interface is designed to meet the needs of those users who want to use any of the PASCO sensors in any combination at the same time. The interface has six input ports and one signal generator output port.

The PASCO 550 Universal Interface can measure data at a rate as fast as one million samples per second (1 Msps), and can output a signal at a frequency as high as one-hundred thousand hertz (100 kHz).

### How do I know if my computer has a USB port?

If your computer has a USB port, you will see the USB symbol (  ) embossed, engraved, or printed next to the port somewhere on your computer. If you purchased a computer that was manufactured in 2001 or later, chances are you have a USB-compatible computer.

It may be possible to add USB ports to your computer using a USB interface card.

### My computer has two USB ports. Can I use more than one PASCO USB interface at the same time?

Yes. PASCO Capstone software allows you to use more than one PASCO USB interface at the same time. However, only one 750 USB *ScienceWorkshop* Interface or 500 *ScienceWorkshop* Interface with a USB/Serial adapter can be used with Capstone.

### Is the 550 Universal Interface compatible with PASCO's complete line of sensors?

Yes. The 550 Universal Interface is compatible with PASPORT sensors ("PS-") and ScienceWorkshop ("CI-") sensors.

### Does the 550 Universal Interface work with *other* software?

No. The 550 Universal Interface requires PASCO Data Collection software (such as PASCO Capstone or SPARKvue).

### Does PASCO Capstone software work with *other* interfaces?

Yes. PASCO Capstone software works with any PASPORT interface such as the USB Link and the SPARKLink Air. The software also works with a 750 USB *ScienceWorkshop* Interface or a 500 *ScienceWorkshop* Interface with a USB/Serial adapter.

PASCO Capstone software will work with the PASCO PI-8127 Function Generator and with USB compatible video cameras.

**If I have the 550 Universal Interface and some PASPORT interfaces connected at the same time, which interface would be recognized first and have priority?**

PASCO Capstone software would give *equal* recognition to all PASPORT interfaces and the Select Measurement Menu in a Capstone display will list all of the sensors for all the recognized interfaces.

## Technical Support

Before you call PASCO technical support, have the apparatus and this user's guide available. Please note the following:

- Product name and model number (e.g., Large Structures Set, ME-7003)
- Approximate age of the product;
- Detailed description of the problem/sequence of events required to duplicate the problem.

For assistance with any PASCO product, contact PASCO at:

Address: PASCO scientific  
10101 Foothills Blvd.  
Roseville, CA 95747-7100

Phone: 916-462-8384 (worldwide)  
877-373-0300 (U.S.)

Web: [www.pasco.com](http://www.pasco.com)

Email: [support@pasco.com](mailto:support@pasco.com)

For the latest information about this product or the latest revision of the Reference Guide, visit the PASCO web site and enter UI-5001 in the Search window.

**Limited Warranty** For a description of the product warranty, see the PASCO catalog.

**Copyright** The PASCO scientific 013-14545A 550 Universal Interface Reference Guide is copyrighted with all rights reserved. Permission is granted to non-profit educational institutions for reproduction of any part of this manual, providing the reproductions are used only in their laboratories and classrooms, and are not sold for profit. Reproduction under any other circumstances, without the written consent of PASCO scientific, is prohibited.

**Trademarks** PASCO, PASCO scientific, Capstone, ScienceWorkshop, DataStudio, PASPORT, and SPARK Science Learning System are trademarks or registered trademarks of PASCO scientific, in the United States and/or in other countries. All other brands, products, or service names are or may be trademarks or service marks of, and are used to identify, products or services of, their respective owners. For more information visit [www.pasco.com/legal](http://www.pasco.com/legal).

### Product End of Life Disposal Instructions:

This electronic product is subject to disposal and recycling regulations that vary by country and region. It is your responsibility to recycle your electronic equipment per your local environmental laws and regulations to ensure that it will be recycled in a manner that protects human health and the environment. To find out where you can drop off your waste equipment for recycling, please contact your local waste recycle/disposal service, or the product representative.

The European Union WEEE (Waste Electronic and Electrical Equipment) symbol on the product or its packaging indicates that this product **must not** be disposed of in a standard waste container.

